





MP-2104
Cabinet

A		∅7x38	10	PCS	D		∅5x70	4	PCS
B		∅5x50	6	PCS	E			2	PCS
C		∅5x50	2	PCS	F				



must be fixed to the wall
OUTILS NECESSAIRE / TOOLS REQUIRED

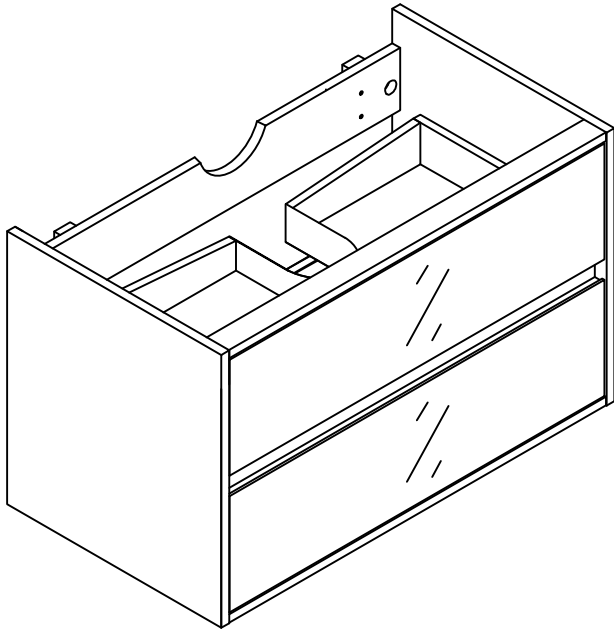
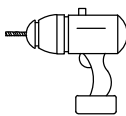
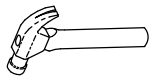
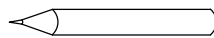
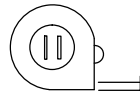
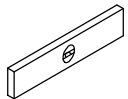

1

Ax10
Bx6
Cx2

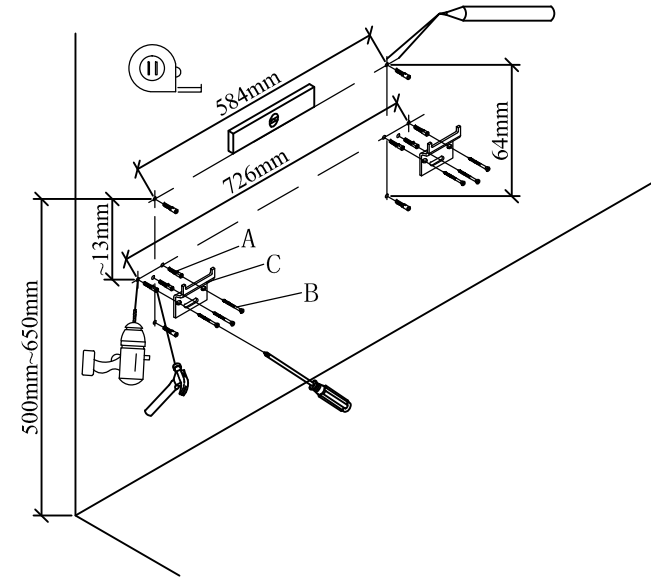

2

Dx4
Ex2

